



Wind power resource assessment for Rafha, Saudi Arabia

S. Rehman^{a,*}, I.M. El-Amin^b, F. Ahmad^a, S.M. Shaahid^a,
A.M. Al-Shehri^b, J.M. Bakhshwain^b

^a*Center for Engineering Research, King Fahd University of Petroleum and Minerals, KFUPM Box #767,
Dhahran 31261, Saudi Arabia*

^b*Electrical Engineering Department, King Fahd University of Petroleum and Minerals,
Dhahran 31261, Saudi Arabia*

Received 1 July 2005; accepted 7 July 2005

Abstract

This paper, presents the analysis of wind speed data and available energy in Rafha area using wind machines of 600, 1000 and 1500 kW sizes from three manufacturers. The long-term annual mean values of wind speeds were found to vary between a minimum of 2.5 m/s in the year 2002 and a maximum of 4.9 m/s in 1990. The frequency distribution showed that wind remained silent for 7% of the time on an average during 24 years of data period and 35% between 0 and 3.5 m/s. Wind speed remained above 3.5 m/s for 65% of the time and only 20% of the times above 6.5 m/s. The annual wind energy production and plant capacity factors, obtained using different methods and wind machines of three sizes and from three manufacturers are also discussed and compared.

© 2006 Elsevier Ltd. All rights reserved.

Keywords: Wind speed; Wind power; Plant capacity factor; Wind machine

Contents

1. Introduction	938
2. Site and data description	939

*Corresponding author. Tel.: +966 3 8603802; fax: +966 3 8603996.

E-mail address: srehman@kfupm.edu.sa (S. Rehman).

URL: <http://staff.kfupm.edu.sa/tri/srehman>.

3. Results and discussion	940
3.1. Wind speed analysis	940
3.2. Mean wind power density variation	942
3.3. Wind speed frequency distribution	944
3.4. Renewable energy yield	944
3.5. Green house gases (ghg) emissions	947
4. Conclusions	948
Acknowledgements	948
References	949

1. Introduction

An accurate wind resource assessment is an important and critical factor to be well understood for harnessing the power of the wind. It is well known that an error of 1% in wind speed measurements leads to almost 2% error in energy output. As we know that wind resources are seldom consistent and vary with time of the day, season of the year, height above the ground, type of terrain and from year to year. As such it should be investigated carefully and completely. The surface roughness and the obstacle in the vicinity of wind measuring tower are also important factors to be considered for wind resource assessment. According to Tennis et al. [1] the wind resource assessment powering a wind farm project is as fundamental to the project's success as rainfall is to alfalfa production. So, one who is interested in a wind farm development should know that how strong are the winds at the site of interest and how much energy the wind farm will produce in these winds.

Michael et al. [2] presented the methodology and results of a wide area wind resources assessment and site selection in Colorado. The authors accomplished the set objective of identifying 20 candidate locations for evaluation and long-term wind monitoring by using a geographic information system (GIS). Potts et al. [3] performed the wind resources assessment of Western and Central Massachusetts using WindMap software, which is based on geographic information systems (GIS). The authors utilized wind speed data from five locations and upper air data from one location as input to WindMap software to produce estimates of wind speed at 50 m. Potts et al. [3] found highest windy areas exist at the corner of northwestern part of Massachusetts. Large winds were also found around Worcester region while weak winds were found near Connecticut River Valley. Brower [4] used GIS based tools to develop wind resource map for New Mexico using wind speed data from 67 stations and elevation data in the region. Brower [5] developed maps for monthly and annual mean wind speeds in Iowa using GIS software. These maps were developed using wind speed data from 21 locations, which would be helpful to interested wind farms developers to obtain reasonably accurate estimates of potential wind energy production at any location in Iowa.

In Saudi Arabia, work on wind resource assessment dates back to 1986 when a wind atlas was developed by using wind speed data from 20 locations [6]. This atlas presented the monthly mean wind speed contours and frequency distribution for all the months during the year. Rehman [7] presented the energy output and economical analysis of 30 MW installed capacity wind farms at five coastal locations in terms of unadjusted energy, gross energy, renewable energy delivered, specific yield and wind farm capacity factor using wind machines of 600, 1000 and 1500 kW. In another study, Rehman [8]

performed a detailed analysis of wind speed in terms of energy yield, effect of hub-height on energy yield, plant capacity factor, etc. for an industrial city situated on the northwest coast of Saudi Arabia. The author found that the long-term wind speed at the site was 4.63 m/s which reached more than 5.0 m/s at 50 m above ground level, the seasonal and diurnal trends followed the electricity demand pattern of the area and the wind was available above 3.5 m/s for 59% of the time during entire year at 10 m above the ground surface. Rehman [8] reported that the smaller wind machine have higher capacity factor than the larger ones.

Rehman and Aftab [9] performed detailed wind data analysis for wind power potential assessment for coastal locations in Saudi Arabia. Rehman et al. [10] computed the cost of energy generation at 20 locations in Saudi Arabia using net present value approach. Mohandes et al. [11,12] used the neural networks method for the prediction of daily mean values of wind speed and concluded that the performance of the neural network model was much better than the performance of the traditionally used auto-regression model. Rehman and Halawani [13] presented the statistical characteristics of wind speed and its diurnal variation. The autocorrelation coefficients were found to match the actual diurnal variation of the hourly mean wind speed for most of the locations used in the study. Rehman et al. [14] calculated the Weibull parameters for 10 anemometer locations in Saudi Arabia and found that the wind speed was well represented by the Weibull distribution function. With growing global awareness of the usage of clean sources of energy, wind energy in particular, a lot of work is being carried out in Saudi Arabia, as can be seen from [15–21].

This paper presents the wind data analysis and available energy in Rafha area using wind machines of 600, 1000 and 1500 kW sizes from three manufacturers. The names of the manufacturer of the machines are identified as MFR1, MFR2 and MFR3. The energy production was calculated using the annual frequency distribution and the wind power curves (WPC) of the wind machines. These values were compared with the energy production obtained using HOMER [22] and RetScreen [23] hybrid power system design tools.

2. Site and data description

Rafha is located in the northeastern part of Saudi Arabia and is surrounded by small villages, which are not connected by national grid. In these villages, the electricity demands are met by using diesel generating power stations. The Saudi Electricity Company, the sole authority providing power to the nation, has established these diesel power generation stations in these localities. These stations are either operated or maintained by SEC or by private contractors. The main concerns areas encountered are the regular supply of diesel fuel and major maintenance case of diesel power generating unit failures. The electric utility has taken initiative to look into the feasibility of using wind power as the partial source of electricity generation at such remote locations. The first and the foremost important step towards wind power development is the understanding of the variability and availability of annual and seasonal wind speed. At Rafha, the wind speed and other meteorological data is being collected since 1970. The data was missing for the years 1976 and 1984 and some months for other years. The hourly mean values of meteorological data were available only during 1970 and 1983 and daily means for rest of the years. The annual

mean values and standard deviations were used to synthesize the hourly values for the years between 1985 and 2004.

The long-term general meteorology of Rafha indicates: the temperature varying between a minimum of -3.8°C and a maximum of 48.4°C while the mean remained as 23.73°C ; the relative humidity varied between 2 and 100% with a mean of 33.5%; and the surface station pressure extremes were 945.5 and 979.2 mb and the mean was 960.55 mb. Moreover, the air density calculated using the temperature and surface pressure was found to vary between a minimum of 1.03 kg/m^3 and a maximum of 1.25 kg/m^3 , while the mean remained as 1.13 kg/m^3 .

3. Results and discussion

This section provides in-depth analysis of wind speed, energy yield and comparison of energy yield with different methods.

3.1. Wind speed analysis

Annual variation of wind speed is of importance from economical, long life, and smooth running of the wind energy conversion system. The annual behavior of wind speed is required to be based on long-term records of wind speeds. The long-term period, as defined by various authors [24–29], varies from 10 to 20 years or more. The annual mean wind speed provide basic information about the wind strength and consequently about the availability of wind power [30]. In order to study the long-term trend of mean wind speed, annual means of the wind speed and wind power density were calculated. An increasing or constant wind speed trend over the years provides confidence to wind farm developers, financiers and designers.

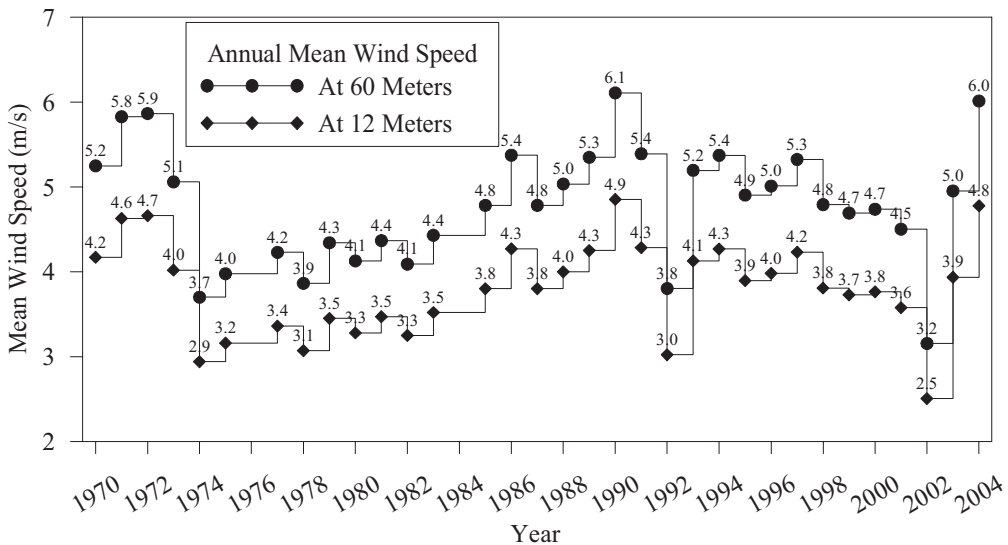

Fig. 1. Variation of annual mean wind speed at 12 and 60 m above ground level.

As shown in Fig. 1, the annual average wind speed varied between a minimum of 2.5 m/s in 2002 and a maximum of 4.9 m/s in 1990. The annual mean values of wind speed showed a cyclic change in the wind speed values after almost every 10 years. In 1970s the wind speed was high while in 1980s it became low and then attained higher values in 1990s. Finally, a decreasing trend was observed towards 2000 and then it increased beyond that. The wind speed calculated at 60 m above ground level is also depicted in this figure. At 60 m, the maximum wind speed was observed in 1990 while the minimum was observed in

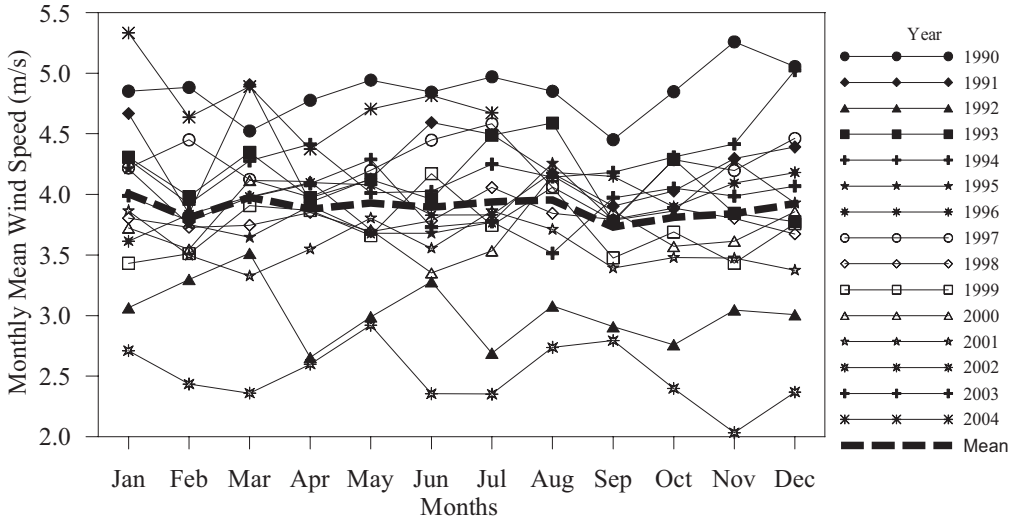

Fig. 2. Seasonal variation wind speed at 12 m above ground level.

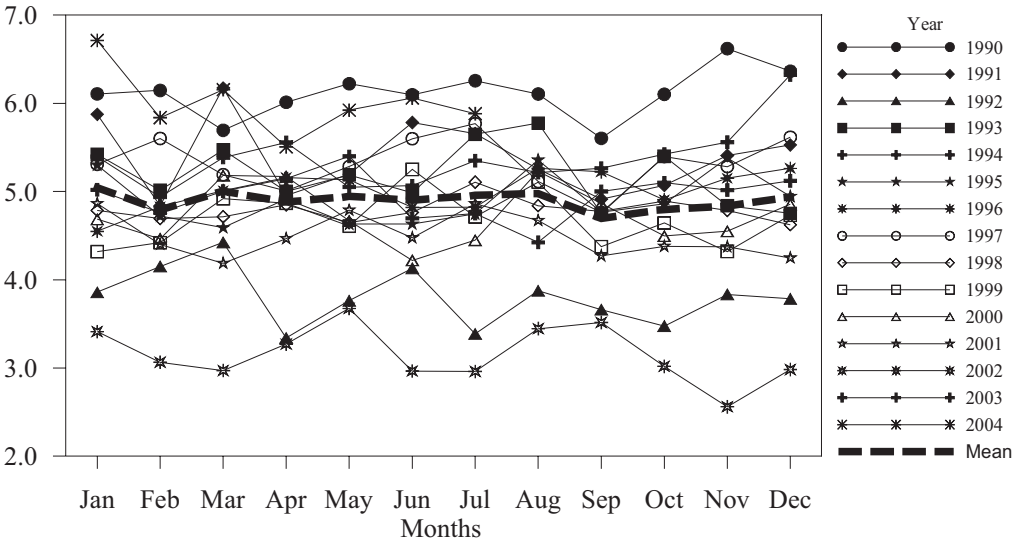

Fig. 3. Seasonal variation wind speed at 60 m above ground level.

2002. The wind speed at 60 m height followed the same trend as that at 12 m height. The seasonal trend of monthly mean values of wind speed at 12 and 60 m above ground level is shown in Figs. 2 and 3, respectively.

As seen from these figures, highest value of monthly mean wind speeds were observed in the year 1990 while lowest was in 2002. During rest of the year the monthly mean values varied between the values corresponding to values in 1990 and 2002. The overall mean monthly values obtained using data collected over entire period does not reflect seasonal change. The long-term monthly mean values found to be 4.0 m/s or less at 12 m above ground level. At 60 m, the long-term wind speed values were found to be 5.0 m/s or less, as shown in Fig. 3.

3.2. Mean wind power density variation

The annual mean wind power density calculated using the air density and daily mean values of wind speed, is shown in Fig. 4. The variation in the values of wind power density matches with the variation of annual mean wind speed values shown in Fig. 1. The lowest value of wind power density of 24 W/m^2 in 2002 corresponds to the lowest wind speed in the same year and the highest value of 87 W/m^2 in 2004 corresponds to the highest wind speed in the same year. The annual mean wind power density values at 60 m above ground level were found to vary between a minimum of 49 W/m^2 and a maximum of 173 W/m^2 corresponding to years 2002 and 2004, respectively, as shown in Fig. 5. It was observed from Figs. 4 and 5 that density values were almost double at 60 m height compared to 12 m height.

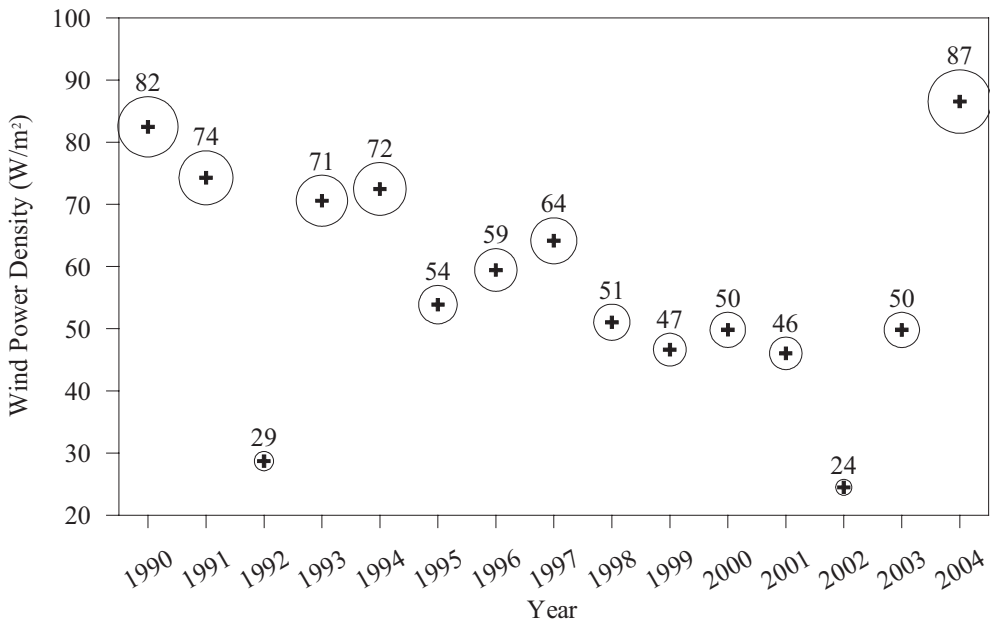

Fig. 4. Annual mean wind power density at Rafha 12m above ground level.

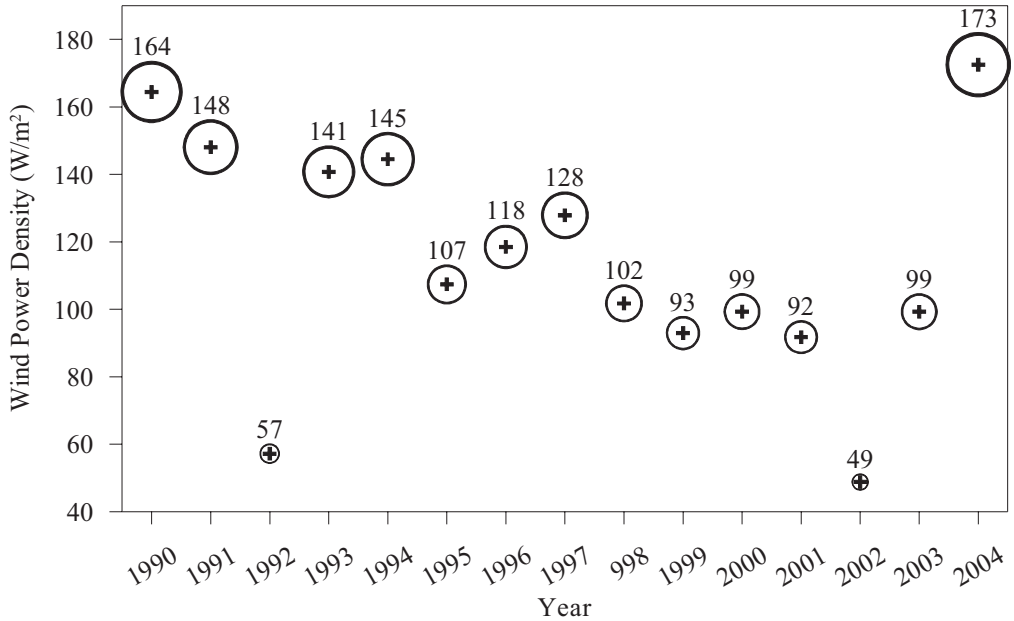

Fig. 5. Annual mean wind power density at Rafha 60 m above ground level.

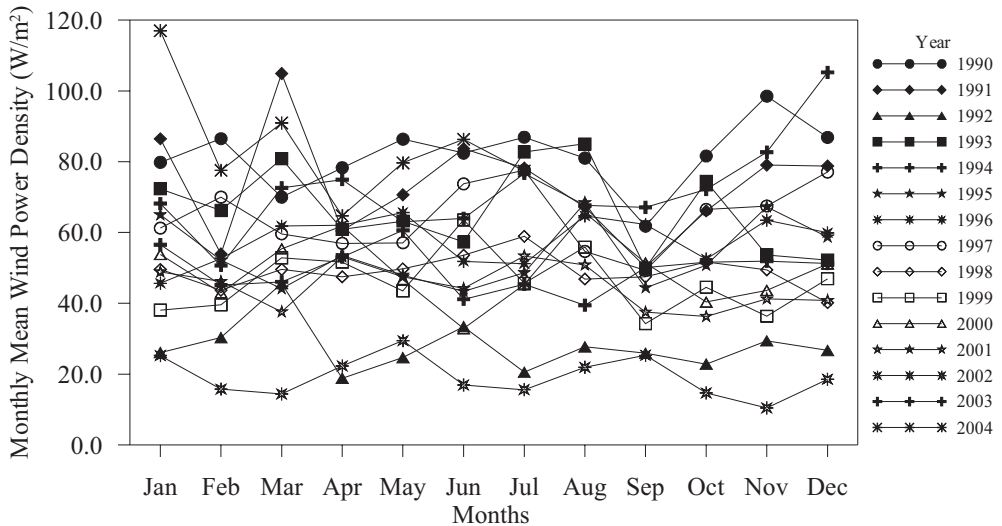

Fig. 6. Seasonal variation of monthly mean wind power density at 12 m above ground level.

In order to study the seasonal behavior of wind power density, monthly mean values were calculated at 12 and 60 m above ground level and are depicted in Figs. 6 and 7, respectively. Over the years, a large variation was seen in wind power density values at

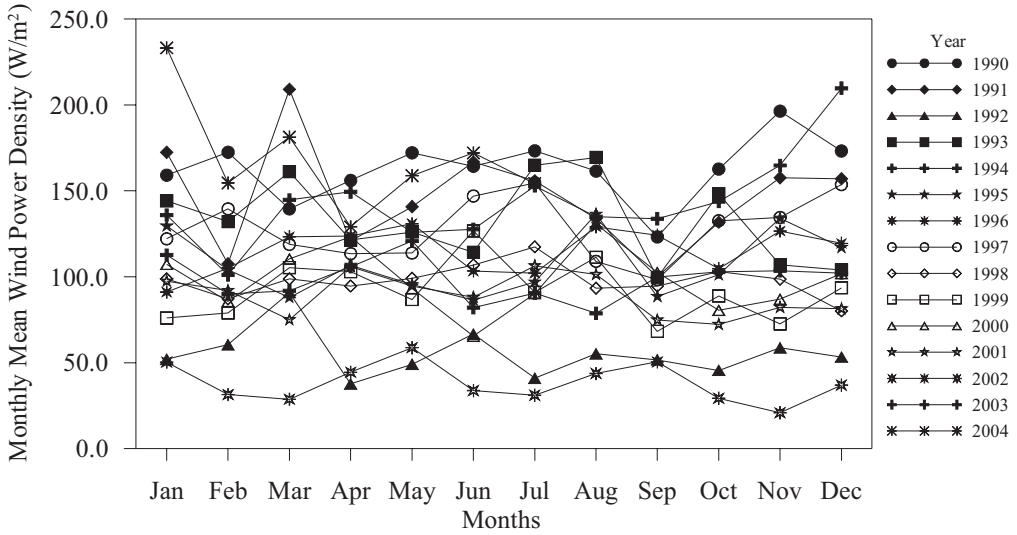

Fig. 7. Seasonal variation of monthly mean wind power density at 60m above ground level.

both heights. The long-term mean values were found to be in the range of 45 and 60 W/m² at 12 m height, as shown in Fig. 6. At 60 m elevation, the wind power density values were found to be above 100 W/m² during most of the months.

3.3. Wind speed frequency distribution

The availability of wind in different wind speed bins obtained using hourly mean wind speed values between 1970 and 2004 are shown in Fig. 8. The frequency distributions at 12 and 60 m height were obtained by constructing the wind rose diagrams. At 60 m, the wind speed was calculated using 1/7th wind power law. The wind was found to remain zero for 7% of the time and between >0 and 3.5 m/s for 40% of the time, at 12 m above ground level. Usually, the commercially available wind turbines start producing energy at or above 3.5 m/s. This shows that wind machines can produce energy for 53% of the time using wind speed at 12 m above ground level.

At 60 m above ground level, as observed from Fig. 9, the wind speed remained silent for 7% of the time during entire data collection period and between >0 and 3.5 m/s for 28% of time. Therefore, it can be said that at Rafha, in the light of existing wind data, the wind turbine can produce energy for 65% of the times. The rated wind speed, usually 12 m/s, at which the wind machine produce rated power, is found only 2% of the times during entire data collection period.

3.4. Renewable energy yield

The energy yield was obtained using three different approaches viz., wind power curve of the wind machine and frequency distribution, the HOMER software and the RetScreen software. The wind power curves of all the wind machines, from three manufacturers, of capacities 600, 1000 and 1500 kW, are shown in Fig. 10. All of these machines start

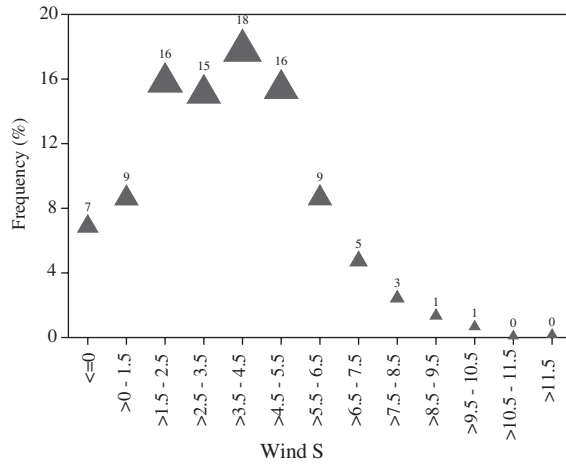

Fig. 8. Percent frequency distribution of hourly mean wind speed at different wind speed bins 12 m above ground level.

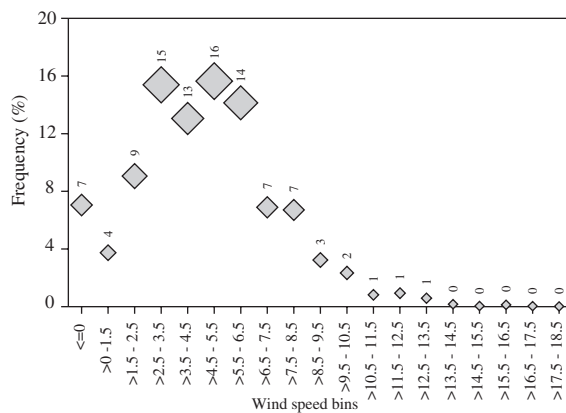

Fig. 9. Percent frequency distribution of hourly mean wind speed at different wind speed bins 60 m above ground level.

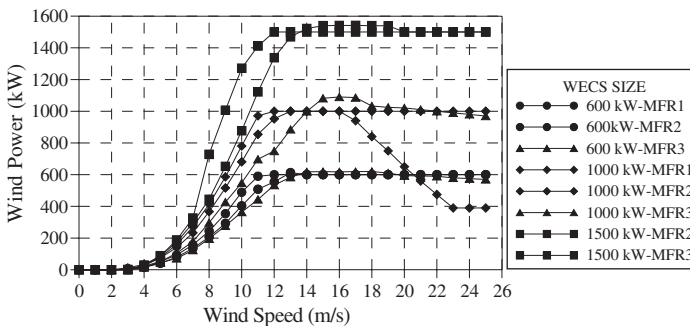

Fig. 10. Wind power curves for different wind machines.

Table 1

Energy yield and plant capacity factor for wind machines from different manufacturers obtained using wind speed data at 60 m

Wind machine size (kW)	Energy yield (MWh/year)			Plant capacity factor (%)		
	MFR1	MFR2	MFR3	MFR1	MFR2	MFR3
600	805	678	642	15.32	12.90	12.22
1000	1332	1180	928	15.20	13.47	10.59
1500	–	1502	1905	–	11.43	14.50

Table 2

Comparison of energy production from 600 kW WECS using different methods for Rafha

WECS type	Wind Data 2002 energy output (MWh/year)			Wind Data 2003 energy output (MWh/year)		
	WPC	HOMER	RetScreen	WPC	HOMER	RetScreen
MFR1	308	304	215	680	681	807
MFR2	247	246	167	559	559	677
MFR3	236	236	162	532	533	638

producing energy at a wind speed of 3.5 m/s or above, as seen from Fig. 10. Even the modern machines, such as shown in Fig. 10, produce a very little amount of energy up to a wind speed of even 6 m/s. Table 1 summarizes the energy yield and the plants capacity factors for wind machines of different sizes obtained using frequency distribution shown in Fig. 9 and the wind power curves of Fig. 10. The plant capacity factors were calculated by dividing the actual energy output during the year by the rated energy output during the same period.

The wind machine of 600 kW rated power from manufacturer MFR1, produced the maximum energy of 805 MWh/year while that from MFR2 produced 678 MWh of energy. Consequently, maximum plant capacity factor of 15.32% was found for wind machine of 600 kW from manufacturer MFR1 and the minimum of 12.22% for wind machine from MFR3. Among 1000 kW sizes, the wind machines from manufacturer MFR1 were found to be most efficient both from energy production and plant capacity factor point of view. In 1500 kW category the wind machine from manufacturer MFR3 performed better than those from manufacturer MFR2 with energy yield of 1905 MWh/year as compared to 1502 MWh/year.

The energy yield also depends on the availability and strength of the wind speed at a given site and the method of calculation. In order to see the effect of wind strength and method of calculation, the energy yield was calculated using wind power curve, HOMER and RetScreen methods for wind speed data of 2002 and 2003. The energy yield, obtained using wind machines of 600 kW rated capacity from three manufacturers is summarized in Table 2. The energy yield values calculated from WPC and HOMER were found to be in close agreement with each other for wind machines from three manufacturers under consideration. The RetScreen method resulted in an average of 45% lower values of energy compared to other methods in case of wind speed data for the year 2002. For wind speed

data of 2003, the energy yields from WPC and HOMER were more than doubled compared to those obtained using wind speed data for the year 2002, as given in Table 2. It is worth mentioning that RetScreen software produced almost four times more energy in 2003 compared to that obtained in 2002.

It is further noticed that RetScreen method produced about 20% more energy in 2003 compared to WPC and HOMER methods for wind machines from all manufacturers. This shows that wind speed frequency distribution plays an important role in energy yield. The energy produced from 1000 kW rated power wind machines using WPC and HOMER methods were found to be comparable with each other while RetScreen values were almost 30% less than other two methods in 2002, as summarized in Table 3. In 2003, the RetScreen values were almost 20% higher than those obtained using WPC and HOMER methods.

3.5. Green house gases (ghg) emissions

The RetScreen software also provides estimates of the quantity of GHG that could be avoided as a result of usage of wind energy for electricity production, as depicted in Fig. 11. A wind machine of 600 kW rated capacity from MFR1 was able to displace 97 ton of GHG in the year 2002 while the same machine was able to displace 365 ton of GHG in the year 2003. This shows the effect of the intensity and distribution of the wind on energy yield and the reduction in GHG. The wind machine of 1000 kW rated power from

Table 3
Comparison of energy production from 1000 kW WECS using different methods for Rafha

WECS type	Wind data 2002 energy output (MWh/year)			Wind data 2003 energy output (MWh/year)		
	WPC	HOMER	RetScreen	WPC	HOMER	RetScreen
MFR1	508	500	353	1130	1131	1336
MFR2	430	429	295	983	985	1177
MFR3	327	326	210	744	746	924

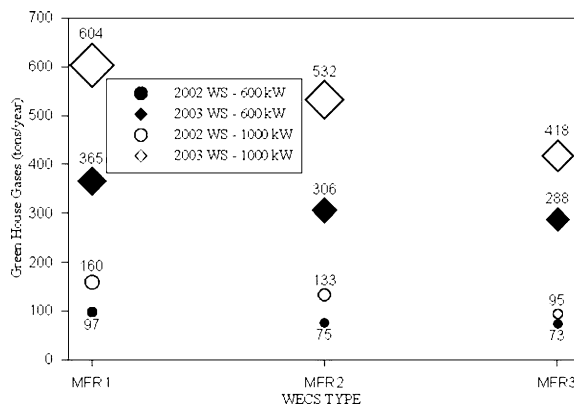

Fig. 11. Green house gases that could be avoided from entering into local atmosphere.

manufacturer MFR1 was able to avoid 160 and 604 ton of GHG from entering into the local atmosphere in the years 2002 and 2003, respectively. As seen from this figure, the wind machines from manufacturer MFR1 avoided maximum GHG from entering into the atmosphere compared to wind machines from other two manufacturers.

4. Conclusions

Based on the analysis of long-term wind speed data and annual energy yield, following observations were made:

The long-term annual mean values of wind speeds were found to vary between a minimum of 2.5 m/s in the year 2002 and a maximum of 4.9 m/s in 1990. The long-term mean wind speed over the entire data collection period was found to be 3.8 m/s at 12 m above ground level. The wind speed at 60 m above ground level, calculated using 1/7 power law, was found to vary between 0 and 25.9 m/s and the mean remained at 4.7 m/s.

The frequency distribution of wind speed at 60 m above ground level in different wind speed bins showed that wind remained silent for 7% of the time on an average during entire data collection period and 35% between 0 and 3.5 m/s. Wind speed remained above 3.5 m/s for 65% of the time and only 20% of the times above 6.5 m/s. Furthermore, the wind hardly reached the rated speed of the wind turbine; hence the rated power of the turbine is hardly achieved. This shows that the power of the wind can be extracted only 65% of the time during the year in small amounts because the larger wind power is available only at higher wind speeds.

The annual wind energy production, obtained using frequency distribution during entire data collection period (Table 1) and wind power curves of 600 kW wind machines, was 805, 678 and 642 MWh/year corresponding to MFR1, MFR2 and MFR3, respectively and the plant capacity factors were 15.32, 12.90 and 12.22%. Similarly, the energy production, obtained using wind machines of 1000 kW rated capacity, was 1332, 1180 and 928 MWh/year corresponding to manufacturer MFR1, MFR2 and MFR3, respectively. The plant capacity factors were found to be 15.20, 13.47 and 10.59%. Finally, 1502 MWh/year of electricity was produced by 1500 kW machine from MFR2 with 11.43% capacity factor and 1905 MWh/year by MFR3 with 14.5% capacity factor.

As seen from the analysis, the wind machines of rated power 600 and 1000 kW from MFR1 performed the best compared to the other two, both in terms of wind energy production and plant capacity factor. On the other hand, wind machine of 1500 kW rated power from MFR3 performed better than the one from MFR2. Theoretically, including the losses, a 10% of plant capacity factor can be achieved at Rafha. Better estimates may be found, if wind measurements can be made at different heights at this location.

The annual mean wind speed and frequency distribution plays an important role in energy production, as seen from energy yields in the years 2002 and 2003. Since, the mean wind speed was higher in 2003 as compared to that in 2002, hence higher energy yields were obtained.

Acknowledgements

The author wishes to acknowledge the support of The Research Institute of King Fahd University of Petroleum and Minerals, Dhahran, Saudi Arabia.

References

- [1] Tennis M.W., Clemmer S., and Howland J., Assessing Wind Resources: A Guide for Landowners, Project Developers, and Power Suppliers, Union of Concerned Scientist.
- [2] Michael C.B., Patrick H., and Rich S., A GIS Assisted Approach to Wide Area Wind Resource Assessment and Site Selection for the State of Colorado, Presented at Windpower 1996, The Annual Conference and Exhibition of the American Wind Energy Association, Denver, Colorado, June 23-27, (1996).
- [3] Potts J.R., Pierson S.W., Mathisen P.P., Hamel J.R., and Babau V.C., Wind Energy Assessment of Western and Central Massachusetts, AIAA-2001-0060, 2001.
- [4] Brower M., New Mexico Wind Resources: AGIS Approach, New Mexico Energy, Minerals, and Natural Resources Department, Final Report, September, (1997).
- [5] Brower M., Iowa Wind Resource Maps: AGIS Approach, Iowa Wind Energy Institute, Final Report, February (1997).
- [6] Ansari J., Madni I.K., and Bakhsh H, Saudi Arabian Wind Energy Atlas, KACST, Riyadh, Saudi Arabia, (1986), pp. 1-27.
- [7] Rehman S., Prospects of Wind Farm Development in Saudi Arabia, *Renewable Energy*, Vol. 30(3), (2004), pp. 447-463.
- [8] Rehman S., Wind Energy Resource Assessment for Yanbo, Saudi Arabia, *Energy Conversion and Management*, Vol. 45(13-14), (2004), pp. 2019 - 2032.
- [9] Rehman S. and Aftab A., Assessment of Wind Energy Potential for Coastal Locations of the Kingdom Saudi Arabia, *Energy - The International Journal*, Vol. 29, (2004), pp. 1105 - 1115.
- [10] Rehman S., Halawani T.O., and Mohandes M., Wind Power Cost Assessment at Twenty Locations in the Kingdom of Saudi Arabia, *Renewable Energy*, 28, (2003), pp. 573-583.
- [11] Mohandes M., Rehman, S., and Halawani, T.O. A Neural Networks Approach for Wind Speed Prediction, *Renewable Energy*, 13(3), (1998), pp. 345-354.
- [12] Mohandes M., Halawani T.O., Rehman S., and Husain, Support Vector Machines for Wind Speed Prediction, *Renewable Energy*, Vol. 29(6), (2004), pp. 939 - 947.
- [13] Rehman, S. and Halawani, T.O. Statistical Characteristics of Wind in Saudi Arabia, *Renewable Energy*, 4(8), (1994), pp. 949-956.
- [14] Rehman, S., Halawani, T.O., and Husain, T. Weibull Parameters for Wind Speed Distribution in Saudi Arabia. *Solar Energy*, 53(6), (1994), pp. 473-479.
- [15] El-Amin I, Shaahid S.M., Rehman S., Al-Shehri A., Bakashwain J. and Ahmad F., Performance and Economic Analysis of Stand-alone Hybrid Wind-diesel Power System for Remote Area Applications of Saudi Arabia, European Wind Energy Conference (EWEC), 22 - 25 November 2004, U.K.
- [16] Rehman S, Ahmad F, El-Amin I, Bader MA, Ahmad A, Rahman MK, Mohandes M. Feasibility of Wind Farm Development in Saudi Arabia. The 8th Arab International Solar Energy Conference & The Regional World Renewable Energy Congress, Kingdom of Bahrain 2004;8-10:2004.
- [17] Rehman S., (2004), Wind Energy Availability and Capacity Factor Analysis, Proceedings of the 2nd BSMEASME International Conference on Thermal Engineering, BUET, Dhaka, Bangladesh, January 02 to 04, 2004, Vol. 2, pp. 900 - 905.
- [18] Rehman S. and Ahmad A., (2004), Assessment of Wind Energy and Capacity Factor Calculations for Two Locations of Saudi Arabia, Proceedings of the 2nd BSME-ASME International Conference on Thermal Engineering, BUET, Dhaka, Bangladesh, January 02 to 04, 2004, Vol. 2, pp. 906 - 911.
- [19] Rehman S., El-Amin I, AL-Shehri A., Bakhshwain J., Ahmad F., Shaahid S.M., Utilization of Wind-Diesel Systems to Provide Power Requirements of Remote Settlements in Saudi Arabia, Fourth International Workshop on Large-Scale Integration of Wind Power and Transmission Networks for Offshore Wind Farms, Royal Institute of Technology, Electric Power Systems, 20-21 October 2003, Denmark.
- [20] Siddiqui, A.H., Khan, S., and Rehman S., (2001), Wavelet based computer simulation for wind speed in Saudi Arabia, Proceedings of the First Saudi Science Conference, King Fahd University of Petroleum and Minerals, Dhahran, Saudi Arabia, Vol. (3), pp. 313-326, 9-11 April 2001.
- [21] Rehman S., (2000), Renewable Energy Education - Its Need and Global Status. Proceedings of The Workshop on Energy Conservation, pp. 389-392, King Fahd University of Petroleum and Minerals, Dhaharn, Saudi Arabia.
- [22] HOMER, National Renewable Energy Laboratory, www.nrel.gov/homer.
- [23] RetScreen International, *Software Manual*, Chapter 2 -Wind Energy Project Analysis, www.retscreen.net.

- [24] Carlin J. and Diesendorf M., Analysis of Some Wind Data from Southern Australia With Reference to Potential Wind Energy Conversion. *Wind Engineering*, Vol. 7, No. 3, pp. 147-160, (1983).
- [25] Palutikof J.P., Kelly P.M., and Davis T.D., Wind Speed Variations and Climate Change. *Wind Engineering*, Vol. 10, No. 4, pp. 182-189, (1986).
- [26] Putnam P.Z., *Power from the Wind*. Van Norstrand Reinhold, New York, (1948).
- [27] Conard V. and Pollak L.K., *Methods in Climatology*. Harvard University Press, Cambridge, Mass, (1962).
- [28] Justus C.G., Mane K., and Mikhail A.S., Interannual and Month-to-Month Variations of Wind Speed. *J. Appl. Meteor*, Vol. 18, pp. 913-920, (1979).
- [29] Pasharde S. and Christofides C., Statistical Analysis of Wind Speed and Direction in Cyprus, *Solar Energy*, Vol. 55, No. 5, pp. 405-414, (1995).
- [30] Baker R.W., Walker S.N., and Wade J.E., Annual and Seasonal Variations in Mean Wind Speed and Wind Turbine Energy Production, *Solar Energy*, Vol. 45, No. 5, pp. 285-289, (1990).